

Instruction Manual for DU06/DU07 Operation Panel

1. Ordering Code

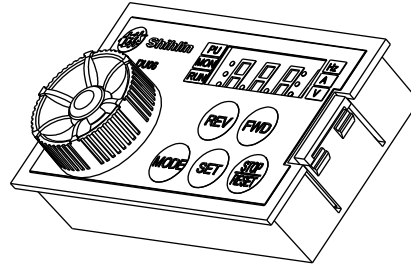
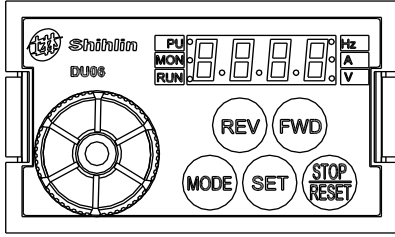

Description on the ordering code:

NO.	Model	Item Name	Ordering Code
1	DU06	DU06 operation panel	SNKDU06
2	DU07	DU07 operation panel	SNKDU07

2. Outline drawing of DU06/DU07

<Outline drawing>

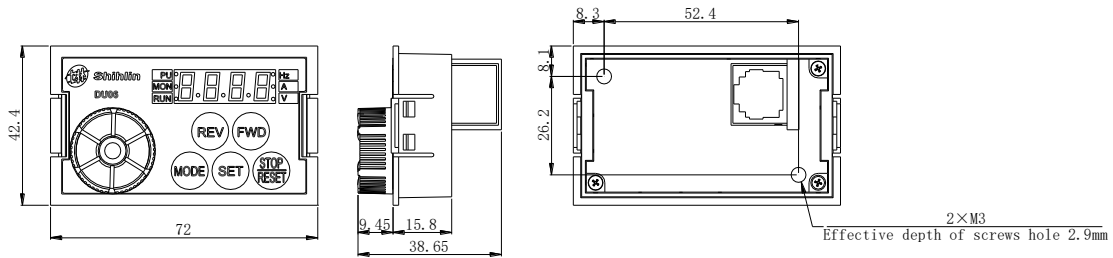

3. Screw installation of DU06/DU07:

<Screw installation: panel cutting dimension drawing>

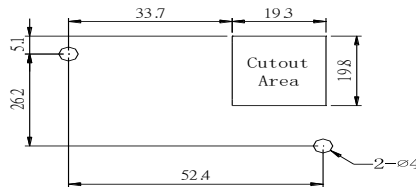

4. Snap-fit installation of DU06/DU07:

<Snap-fit installation: panel cutting dimension drawing>

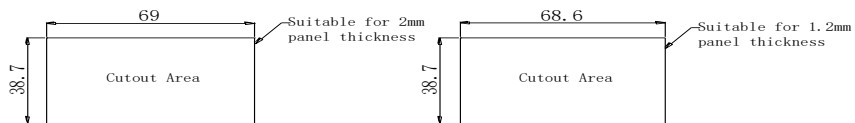

5. Clip installation of DU06/DU07:

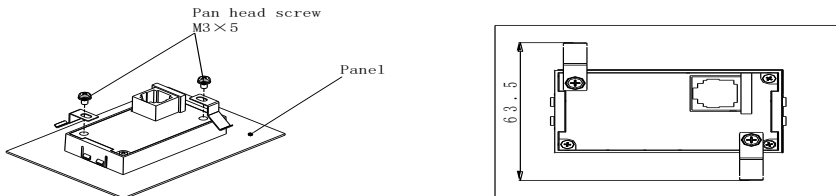

6. CBL: Data transmission line (coordinated with the operation panel)

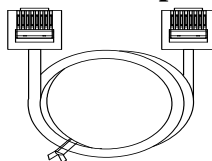

Description on the ordering code:

NO.	Model	Item name	Ordering code
1	CBL1R5GT	Data transmission line (Length: 1.5M)	SNKCBL1R5GT
2	CBL03GT	Data transmission line (Length: 3M)	SNKCBL03GT
3	CBL05GT	Data transmission line (Length: 5M)	SNKCBL05GT

7. Primary Operation

7.1 The flow chart for switching the operation mode

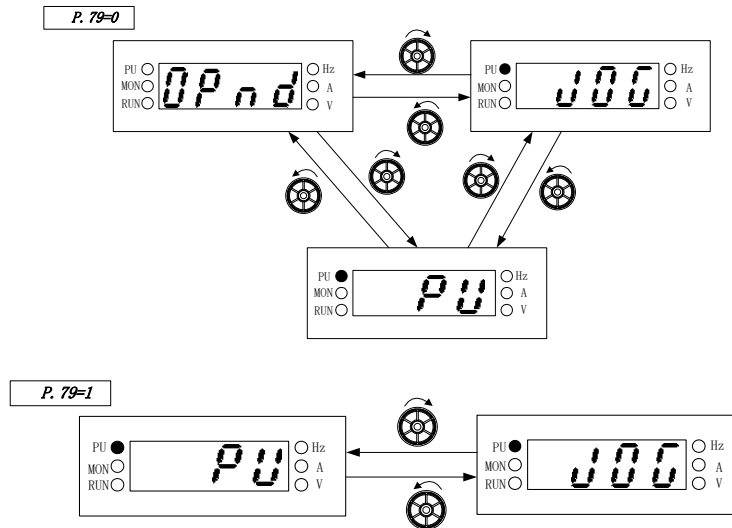

Note: 1. At the PU mode, the indicating lamp **PU** in the operation panel will be lit up.
 2. At the external mode, the display screen will display **OPnd**
 3. At the combined mode 1, 2, 3, 4 or 5, the indicating lamp **PU** will flicker.
 4. At the JOG mode, the indicating lamp **PU** will be lit up, and at the same time the display screen will display **JOG** while the motor is not running.
 5. The operation mode will be constant if P.79 is equal to 2, 3, 4, 5, 6, 7 or 8, so there are no flow charts for it.
 6. It needs to press "SET" key to set the operation mode after switching.

7.2 The flow chart for switching the working mode

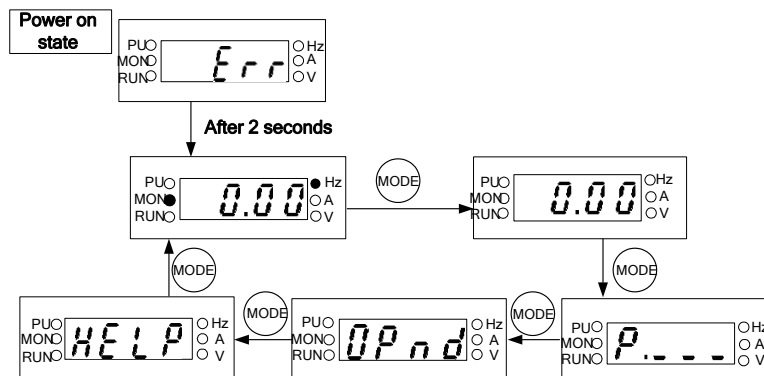

Note: 1. For detailed operating flow at monitoring mode, please refer to Section 4.1.3 of SS2 series inverter instruction manual.
 2. For detailed operating flow at frequency setting mode, please refer to Section 4.1.4 of SS2 series inverter instruction manual.
 3. For detailed operating flow at parameter setting mode, please refer to Section 5.3.
 4. For detailed operating flow at **HELP** mode, please refer to Section 4.1.6 of SS2 series inverter instruction manual.

7.3 Operating flow chart for the parameter setting mode

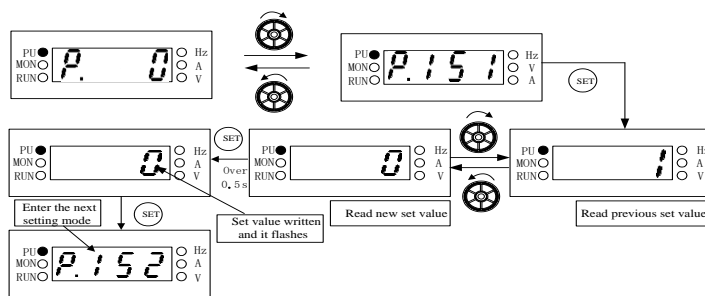

Note: At the parameter setting mode, both the indicating lamp of **Hz** and **MON** will be off. Please make sure to hold down the **SET** key for more than 0.5s when writing for the set value of the parameters.

7.4 Parameter Copy Function (Pr.CP, Pr.CA)

Pr.CP “Parameter copy readout”

Pr.CA “Parameter copy write-in”

- Parameter copy function is valid only when the motor is stop, P.77=0, and under the PU mode. If several inverters need set same parameter values, just only set one inverter parameters, then use Pr.CP and Pr.CA to quickly copy the values to other inverters.

- Parameter copy operation procedure:

- When the first inverter is in the PU mode, press **MODE** to switch to the parameter setting mode. Rotate **▲** until **Pr.CP** is displayed, and it will display “0” after pressing **SET**. Then rotate **▲** to change the value to “1” and write in by pressing **SET**. The screen will display the parameter number one by one, which indicates that the parameters are copied from the inverter to the operation panel. When the parameter copying is completed the screen will display **End** and flickering.
- When the second inverter is in the PU mode, after **Pr.CA** is read out, the screen of the panel will display the initial value “0”. Rotate **▲** to change the value to “1” and write in by pressing **SET**. The screen will display the parameter number one by one, which indicates that the parameters are copied from the operation panel to the inverter. When the parameter copying is completed, the screen will display **End** and flickering.

Note: 1. If the version of the inverter is updated, pick inverter parameters of the lower version inverter among inverters of different versions for parameter copying.
 2. Parameters cannot be copied between inverters of different series.
 3. When parameters cannot be copied, DU06/DU07 operation panel will display the alarm code “Err”. These alarm codes are not the abnormal alarm codes. When these alarm codes are displayed, inverter reset is not required.

7.5 Alarm History Clear (Er.CL)











- The method: Press **MODE** to switch to the parameter setting mode, and then rotate **▲** until **Er.CL** is displayed. After pressing **SET**, 0 will be displayed. After that, rotate **▲** to change the value to 1 and press **SET** to write in. At last, all the alarm history will be cleared.

7.6 Inverter Reset (rEST)









- The method: Press **MODE** to switch to the parameter setting mode, and then rotate **▲** until **rEST** is displayed. After pressing **SET**, 0 will be displayed. After that, rotate **▲** to change the value to 1 and press **SET** to write in that the inverter will be reset. After that, the thermal accumulation value of the electronic thermal relay capacity and the electronic thermal relay of the inverter’s IGBT module will return to zero.

7.7 Restoring all parameters to default values (ALLC)









Restoring some parameters to default values (PrCr)

- The method for the function of restoring all parameters to default values: Press  to switch to the parameter setting mode, and then rotate  until **ALLC** is displayed. After pressing , 0 will be displayed. After that, rotate  to change the value to 1 and press  to write in that all the parameters except P.21, P.188, P.189, P.292, P.293 will be restored to the factory setting value.
- The method for the function of restoring some parameters to default values: Press  to switch to the parameter setting mode, and then rotate  until **PrCr** is displayed. After pressing , 0 will be displayed. After that, rotate  to change the value to 1 and press  to write in that all the parameters except P.21, P.188, P.189, P.190~P.199, P.292, P.293, P.300~P.309 will be restored to the factory setting value.
- When the operation of restoring all or some parameters to default values is carried out, please make sure that other operations are done after **End** is displayed on the screen which means that the parameters have restored to default values.

7.8 Automatic writing frequency function selection (PU_F)

- After DU06 automatic writing frequency function is selected, target frequency can be changed by rotating  when inverter is in target frequency mode (such as PU mode, combined mode 1) given by operation panel and DU06 is in monitoring mode or target frequency setting mode. And the target frequency changed will be written into inverter immediately without action of pressing  key.
- The method: Press  to switch to **HELP** mode, and press , and then rotate  until "PU_F" is displayed. After pressing , the value will be displayed, and you can rotate  to change the value in the range of 0~2. Rotate to the value which is changed to, then press  to write in as long as the **End** flickers which means the written is finished.
- The meaning of setting value of "PU_F" is as follows:
 - “0”: has not automatic writing frequency function. To write the target frequency of DU06 panel into inverter, you must press  to write in.
 - “1”: has automatic writing frequency function. When the power is off, the target frequency's save period is 10 seconds.
 - “2”: has automatic writing frequency function. When the power is off, the target frequency's save period is 30 seconds.

7.9 Setting Dial "SET" Function Selection (SET)

- When setting dial "set" function is selected, pressing setting dial down works as  does.
- The method: Press  to switch to **HELP** mode, and press , then rotate  until "SET" is displayed. After pressing , the value will be displayed, and you can rotate  to change the value in the range of 0~1. Rotate to the value which you want, then press setting dial to write in as long as the **End** flickers which means the written is finished.
- The meaning of "PU_F" setting value is as follows:
 - “0”: the setting dial has no  function
 - “1”: the setting dial has  function

Others

To improve our products, the parameters and contents may be modified, please contact the agent or refer to Shihlin websites (<http://automation.seec.com.tw/>) to download the latest version

